



Inverter RS Smart

Table of Contents

1. Safety Instructions	1
2. General Description	3
2.1. High efficiency	3
2.2. Frequency shift function	3
2.3. High power, safe operation	3
2.4. Interfacing and Communications	3
2.5. Battery charger	4
2.6. Setup options	4
3. Installation	5
3.1. Location of the inverter	5
3.2. MPPT grounding and detection of PV array insulation faults	5
3.3. Battery and battery lead requirements	6
3.4. Solar array configuration	6
3.4.1. Inverter RS Example PV Configuration	6
3.5. Cable connection sequence	7
3.6. Connection to the load	7
3.7. VE.Direct	7
3.8. VE.Can	7
3.9. Bluetooth	7
3.10. User I/O	7
3.10.1. Remote on/off connector	7
3.10.2. Programmable relay	8
3.10.3. Voltage sense	8
3.10.4. Temperature sensor	8
3.10.5. Programmable analog/digital input ports	8
3.10.6. User I/O terminal diagram	8
3.10.7. User I/O functions	8
3.11. Programming with VictronConnect	9
3.11.1. Settings	9
3.11.2. Battery settings	10
4. Operation	13
4.1. Device display	13
4.2. STATUS - Live Data Information	14
4.3. HISTORY - Thirty-day Graphic	15
4.4. Protections and automatic restarts	16
4.4.1. Overload	16
4.4.2. Low battery voltage thresholds (adjustable in VictronConnect)	16
4.4.3. High battery voltage	16
4.4.4. High temperature	17
5. Troubleshooting	18
6. Technical Specifications	19
7. Appendix	21
7.1. Appendix A : Connection Overview	22
7.2. Appendix B : Block Diagram	25
7.3. Appendix C : Example Wiring Diagram	26
7.4. Appendix D : Dimensions	27

1. Safety Instructions



ELECTRIC SHOCK HAZARD

Please read this manual carefully before the product is installed and put into use.

This product is designed and tested in accordance with international standards. The equipment should be used for the designated application only.

Refer to the specifications provided by the manufacturer of the battery to ensure that the battery is suitable for use with this product. The battery manufacturer's safety instructions should always be observed.

Protect the solar modules from incident light during installation, e.g. cover them.

Never touch uninsulated cable ends.

Use only insulated tools.

Connections must always be made in the sequence described in the installation section of this manual.

The installer of the product must provide a means for cable strain relief to prevent the transmission of stress to the connections.

In addition to this manual, the system operation or service manual must include a battery maintenance manual applicable to the type of batteries used.



SELECTION OF WIRE CONDUCTORS

Use flexible multistranded copper cable for the battery and PV connections.

The maximum diameter of the individual strands is 0,4mm/0,125mm² (0.016 inch/AWG26).

A 25mm² cable, for example, should have at least 196 strands (class 5 or higher stranding according to VDE 0295, IEC 60228 and BS6360).

An AWG2 gauge cable should have at least 259/26 stranding (259 strands of AWG26)

Maximum operating temperature: $\geq 90^{\circ}\text{C}$

Example of suitable cable: class 5 "Tri-rated" cable (it has three approvals: American (UL), Canadian (CSA) and British (BS)).

In case of thicker strands the contact area will be too small and the resulting high contact resistance will cause severe overheating, eventually resulting in fire.



RISK OF INJURY OR DEATH

The internals can carry a 400-500V DC voltage even when the product is off!

Input and/or output terminals may still be dangerously energized, even when the equipment is switched off. Always disconnect all power connections (e.g. the battery, DC solar isolator, etc) and wait at least 5 minutes before carrying out work on the product.

The product has no internal user-serviceable components. Do not remove the front plate or operate the product if any panels have been removed. All servicing must be undertaken by qualified personnel.

Please read the installation instructions in the installation manual before installing the equipment.

This is a Safety Class I product (supplied with a protective grounding terminal). The chassis must be grounded. Whenever it is likely that the grounding protection has been damaged, the product must be turned off and secured against unintended operation; please contact qualified service staff.

Environment and Access

Ensure that the equipment is used under the correct ambient conditions. Never operate the product in a wet or dusty environment. Never use the product where there is a risk of gas or dust explosions. Ensure there is adequate free space for ventilation above and below the product and check that the ventilation vents are not blocked.

Installation of this product must in a location that restricts access by persons (including children) with reduced physical, sensory or mental capabilities, or lack of experience and knowledge, unless they have been given supervision or instruction concerning use of the appliance by a person responsible for their safety.

2. General Description

The Inverter RS is a combined battery inverter and MPPT solar charge controller. It is designed to operate with a 48V battery bank, a PV input voltage range of between 80-450V, and produces a pure AC sine wave at 230V.

- Low battery voltage alarm trip and reset levels
- Low battery voltage cut-off and restart levels, or Dynamic cut-off
- Adjustable Output AC voltage 210 - 245V
- Select Frequency 50 Hz or 60 Hz

2.1. High efficiency

Ultra-fast Maximum Power Point Tracking (MPPT) - Especially in case of a clouded sky, when light intensity is changing continuously, a fast MPPT algorithm will improve energy harvest by up to 30% compared to PWM charge controllers and by up to 10% compared to slower MPPT controllers.

Advanced Maximum Power Point Detection in case of partial shading conditions - If partial shading occurs, two or more maximum power points may be present on the power-voltage curve. Conventional MPPTs tend to lock to a local MPP, which may not be the optimum MPP. The innovative SmartSolar algorithm will always maximize energy harvest by locking to the optimum MPP.

Outstanding conversion efficiency - Maximum efficiency of 96%. The inverter is short circuit proof and protected against overheating, whether due to overload or high ambient temperature.

2.2. Frequency shift function

When external PV inverters are connected to the output of the inverter, excess solar energy is used to recharge the batteries, just as with the internal MPPT solar controller. Once the battery absorption voltage is reached, charge current will reduce by shifting the output frequency higher. This feature is used for battery over charge protection and solar assist. It does not allow charging the battery to fully charge to 100% SoC for safety reasons.

2.3. High power, safe operation

High Peak Power - The maximum AC output power can increase to up to a peak 9000W or 50A AC, when sufficient PV power is also available to support the battery supply.

Isolated PV connections for additional safety - Full galvanic isolation between PV and battery connections provide additional overall system safety.

Temperature Protected - Over-temperature protection and power derating when temperature is high.

2.4. Interfacing and Communications

Bluetooth Smart built-in

The wireless solution to set-up, monitor and update the controller using Apple and Android smartphones, tablets or other compatible devices. No additional dongle or accessory required.

VE.Direct port and two VE.Can ports

Either communications port type can be used for a wired data connection to a GX device (e.g. Cerbo GX, Color Control GX) PC or other devices. Note that only one port can be used at a time.

Device Display

A 4 line LCD backlit display that operational information including battery levels, solar yield, and system icons.

User I/O connector:

- Aux 1, 2 input
- Programmable relay
- Battery Vsense
- Battery Tsense
- Remote H & Remote L - Configurable

Configuring and monitoring with VictronConnect

Configure the solar charge controller with the VictronConnect app. Available for iOS, Android devices, as well as macOS and Windows computers. An accessory might be required for some systems; enter VictronConnect in the search box on our website and see the VictronConnect download page for details.

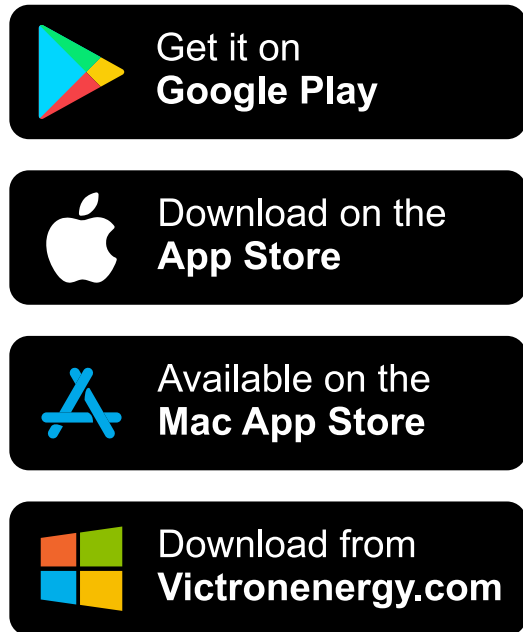

2.5. Battery charger

The batteries are charged by solar energy using the built-in MPPT solar controller. It can also be charged by a PV grid inverter connected to the AC out. In this case the battery will be charged to ~98%. The built-in MPPT has a power limit of 4000W. So the maximum charging current for a 50V battery will be 80A. If an additional PV grid inverter is connected (max 5000W) the maximum total charging current is limited to 100A. The maximum charging current of 100A is reduced if battery voltage goes above 60V. A custom maximum charge current value can also be defined by the installer in VictronConnect.

The charger algorithm is the same as for the BlueSolar MPPT solar controllers. This provides built-in battery preset parameters, and allows for expert mode to define additional charging parameters. Please see the MPPT section of the VictronConnect manual for additional explanation of these charging features.

2.6. Setup options

Adaptive three step charging

The MPPT Charge Controller is configured for a three step charging process: Bulk – Absorption – Float.

A regular equalization charge can also be programmed.

Bulk- During this stage the controller delivers as much charge current as possible to rapidly recharge the batteries.

Absorption - When the battery voltage reaches the absorption voltage setting, the controller switches to constant voltage mode. When only shallow discharges occur the absorption time is kept short in order to prevent overcharging of the battery. After a deep discharge the absorption time is automatically increased to make sure that the battery is completely recharged.

Additionally, the absorption period is also ended when the charge current decreases to less than 2A.

Float - During this stage, float voltage is applied to the battery to maintain a fully charged state.

Optional external voltage and temperature sensor

Wired connections are available for battery voltage and temperature sensing. The Solar Charger uses these measurements to optimize its charge parameters. The accuracy of the data it transmits will improve battery charging efficiency, and prolong battery life.

The Smart Battery Sense and other VE.Smart networking features are not currently supported.

Remote on-off input

On/off control by a VE.Bus BMS when charging Li-ion batteries.

Remote L functions as 'allow to charge' in case lithium battery is selected and remote H functions as 'allow to discharge'. Use smallBMS for the RS with Victron lithium batteries.





Programmable relay

Can be programmed (with a smartphone) to open or close on an alarm, or other events.

3. Installation

3.1. Location of the inverter

Table 1.

	<p>For best operating results, the inverter should be placed on a flat surface. To ensure a trouble free operation of the inverter, it must be used in locations that meet the following requirements:</p> <ol style="list-style-type: none"> Avoid any contact with water. Do not expose the inverter to rain or moisture. Do not place the unit in direct sunlight. Ambient air temperature should be between -20°C and 40°C (humidity $< 95\%$ non-condensing). Do not obstruct the airflow around the inverter. Leave at least 30 centimeters clearance above and below the inverter. <p>When the unit is running too hot, it will shut down. When it has reached a safe temperature level the unit will automatically restart again.</p>
	<p>This product contains potentially dangerous voltages. It should only be installed under the supervision of a suitable qualified installer with the appropriate training, and subject to local requirements. Please contact Victron Energy for further information or necessary training.</p>
	<p>Excessively high ambient temperature will result in the following:</p> <ul style="list-style-type: none"> Reduced service life. Reduced charging current. Reduced peak capacity, or shutdown of the inverter. <p>Never position the appliance directly above lead-acid batteries. The Inverter RS is suitable for wall mounting. For mounting purposes, a hook and two holes are provided at the back of the casing. The device must be fitted vertically for optimal cooling.</p>
	<p>For safety purposes, this product should be installed in a heat-resistant environment. You should prevent the presence of e.g. chemicals, synthetic components, curtains or other textiles, etc., in the immediate vicinity.</p>

Try and keep the distance between the product and the battery to a minimum in order to minimise cable voltage losses

3.2. MPPT grounding and detection of PV array insulation faults

The RS will test for sufficient resistive isolation between PV+ and GND, and PV- and GND. In the event of a resistance below the threshold, the unit will stop charging, display the error, and send the error signal to the GX device (if connected) for audible and email notification.

The positive and negative conductors of the PV array must be isolated from ground.

Ground the frame of the PV array to local requirements. The ground lug on the chassis should be connected to the common earth.

The conductor from the ground lug on the chassis of the unit to earth should have at least the cross-section of the conductors used for the PV array.

When a PV resistance isolation fault is indicated, do not touch any metal parts and immediately contact a suitably qualified technician to inspect the system for faults.

The battery terminals are galvanically isolated from the PV array. This ensures that PV array voltages cannot leak to the battery side of the system in a fault condition.

3.3. Battery and battery lead requirements

In order to utilize the full capacity of the product, batteries with sufficient capacity and battery cables with sufficient cross section should be used. The use of undersized batteries or battery cables will lead to:

- Reduction in system efficiency.
- Unwanted system alarms or shutdowns.
- Permanent damage to system.

See table for MINIMUM battery and cable requirements.

Model		
Battery capacity Pb		200 Ah
Battery capacity Lithium		50 Ah
Recommended DC fuse		125 A - 150 A
Minimum cross section (mm ²) per + and - connection terminal	0 - 2 m	35 mm ²
	2 - 5 m	70 mm ²



Consult battery manufacture recommendations to ensure the batteries can take the total charge current of the system. Decision on battery sizing should be made in consultation with your system designer.



Use a torque wrench with insulated box spanner in order to avoid shorting the battery.

Maximum torque: 14 Nm

Avoid shorting the battery cables.

- Undo the two screws at the bottom of the enclosure and remove the service panel.
- Connect the battery cables.
- Tighten the nuts well for minimal contact resistance.

3.4. Solar array configuration

The maximum operational input current for each tracker is 18A.

MPPT PV inputs are protected against reverse polarity, to a maximum short circuit current of 20A for each tracker.

Connecting PV arrays with a higher short circuit current is possible, as long as connected with correct polarity. This outside of specification potential allows for system designers to connect larger arrays, and can be useful in case a certain panel configuration results in a short circuit current just slightly above 20A, or to oversize the array to take care of winter versus summer PV yield.



While functional with correct installation, BEWARE that the product warranty will be void if a PV array with a short circuit current larger than 20A array is connected in reverse polarity.

When the MPPT switches to float stage it reduces battery charge current by increasing the PV Power Point voltage.

The maximum open circuit voltage of the PV array must be less than 8 times the minimum battery voltage when at float.

For example, where a battery has a float voltage of 54.0 volts, the maximum open circuit voltage of the connected array cannot exceed 432 volts.

Where the array voltage exceeds this parameter the system will give a "Over-charge Protection" error and shut down.

To correct this, either increase the battery float voltage, or reduce PV voltage by removing panel from the string.

3.4.1. Inverter RS Example PV Configuration



This is an example of an array configuration. The decision on the specific array configuration, sizing and design for your system should be made in consultation with your system designer.

Table 2. PV Array Example

Panel Type	Voc	Vmpp	Isc	I _{mp}	# of panels	Max String Voltages	Power total
Victron 260W (60 cell)	36.75 V	30 V	9.30 A	8.66 A	#1 - 8 #2 - 8	304 V	4160 W

3.5. Cable connection sequence

First: Confirm correct battery polarity, connect the battery.

Second: if required, connect the remote on-off, and programmable relay, and communications cables

Third: Confirm correct PV polarity, and then connect the solar array (if incorrectly connected with reverse polarity, the PV voltage will drop, the controller will heat up but will not charge the the battery). Torque: 2,4 Nm

3.6. Connection to the load

Never connect the output of the inverter to another AC supply, such as a household AC wall outlet or AC wave forming petrol generator. Wave synchronising PV solar inverters can be connected to the AC output, see section on Frequency Shift Function for more information.



The Inverter RS is a safety class I product (supplied with a ground terminal for safety purposes). **Its AC output terminals and/or grounding point on the outside of the product must be provided with an uninterruptible grounding point for safety purposes.**

The Inverter RS is provided with a ground relay that **automatically connects the Neutral output to the chassis**. This ensures the correct operation of the internal earth leakage switch and an earth leakage circuit breaker that is connected to the output.

- In a fixed installation, an uninterruptible grounding can be secured by means of the grounding wire of the AC input. Otherwise the casing must be grounded.
- In a mobile installation (for example, with a shore current plug), interrupting the shore connection will simultaneously disconnect the grounding connection. In that case, the casing must be connected to the chassis (of the vehicle) or to the hull or grounding plate (of the boat).

Torque: 2 Nm

3.7. VE.Direct

Used to connect a PC/laptop to configure the inverter.

3.8. VE.Can

Used to connect to a GX Device.

3.9. Bluetooth

Used to connect to the device via VictronConnect for configuration.

3.10. User I/O

3.10.1. Remote on/off connector

The remote on/off has two terminals: Remote L and Remote H.

A remote on/off switch or relay contact can be connected between L and H. Alternatively, terminal H can be switched by a connection to battery positive, or terminal L can be switched by a connection to battery minus.

Special case for Victron lithium batteries in combination with the smallBMS. When Lithium is selected in the software, the remote on/off is changed, and that physical interface instead becomes the connection point for the allow-to-charge and allow-to-discharge wires.

The remote H input is the connection point for the allow-to-discharge control wire and must be connected to the Load output of the smallBMS. The remote L input is the connection point for the allow-to-charge control wire and must be connected to the Charger output of the smallBMS. Remote on/off function is now taken over by the smallBMS.

3.10.2. Programmable relay

Programmable relay which can be set for general alarm, DC under voltage or genset start/stop function. DC rating: 4A up to 35VDC and 1A up to 70VDC

3.10.3. Voltage sense

For compensating possible cable losses during charging, two sense wires can be connected directly to the battery or to the positive and negative distribution points. Use wire with a cross-section of 0,75mm².

During battery charging, the charger will compensate the voltage drop over the DC cables up to a maximum of 1 Volt (i.e. 1V over the positive connection and 1V over the negative connection). If the voltage drop threatens to become larger than 1V, the charging current is limited in such a way that the voltage drop remains limited to 1V.

3.10.4. Temperature sensor

For temperature-compensated charging, the temperature sensor (supplied with the unit) can be connected. The sensor is isolated and must be fitted to the negative terminal of the battery. The temperature sensor can also be used for low temperature cut-off when charging lithium batteries (configured in VictronConnect).

3.10.5. Programmable analog/digital input ports

The product is equipped with 2 analog/digital input ports.

The digital inputs are 0-5v, and when a input is pulled to 0v it is registered as 'closed'

These ports can be configured in VictronConnect. For more information search Victron Community.

3.10.6. User I/O terminal diagram

Figure 1.

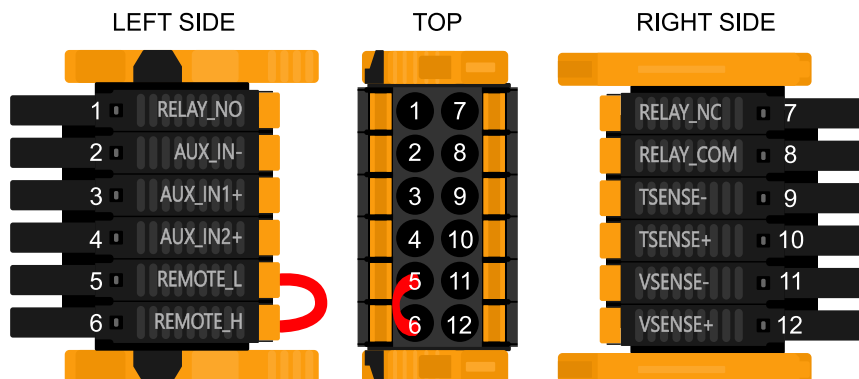

User I/O Connector is located on bottom left side of connection area, diagram shows 3 perspectives. Left Side - Top - Right Side

3.10.7. User I/O functions

Table 3. User I/O Functions - See Installation Section for more details.

Number	Connection	Description
1	Relay_NO	Programmable relay Normally Open connection
2	AUX_IN -	Common negative for programmable auxiliary inputs
3	AUX_IN1+	Programmable auxiliary input 1 positive connection
4	AUX_IN2+	Programmable auxiliary input 2 positive connection
5	REMOTE_L	Remote on/off connector Low
6	REMOTE_H	Remote on/off connector High
7	RELAY_NC	Programmable relay Normally Closed connection
8	RELAY_COM	Programmable relay common negative
9	TSENSE -	Temperature Sensor negative

Number	Connection	Description
10	TSENSE +	Temperature Sensor positive
11	VSENSE -	Voltage Sensor negative
12	VENSE +	Voltage Sensor positive

3.11. Programming with VictronConnect

This guide will help you with the specific elements of VictronConnect that relate to the MPPT Solar Charge Controller.

More general information about the VictronConnect App - how to install it; how to pair it with your device; and how to update firmware, for example - can be found by referring to the overall [VictronConnect manual](#). A list of all VictronConnect compatible devices can be viewed [here](#).

Note: These instructions can apply to different products and configurations, where battery voltage is referred to in these instructions, a 12V battery is used as a reference point. Please multiply the given values by 4 to arrive at settings for an installation configured for the 48V battery system.

3.11.1. Settings

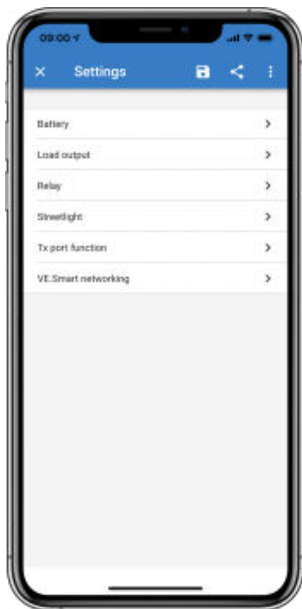

The settings page is accessed by clicking on the Cog icon at the top right of the Home page. The settings page provides access to view or change the settings of the Battery; Load; Streetlight; and Port functions. From this page you can also view Product information such as the Firmware versions installed on the MPPT Solar Charger.

3.11.2. Battery settings

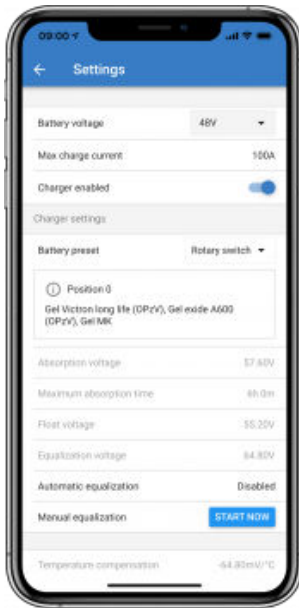

Battery voltage

The RS is fixed to 48V, and is only available for 48V systems.

Max charge current

Allows the user to set a lower maximum charge current.

Charger enabled

toggling this setting turns the Solar Charger off. The batteries will not be charged. This setting is intended only for use when carrying-out work on the installation.

Charger settings - Battery preset

Battery preset allows you to select the battery type; accept factory defaults; or enter your own preset values to be used for the battery charge algorithm. The Absorption voltage, Absorption time, Float voltage, Equalisation voltage and Temperature compensation settings are all configured to a preset value - but can be user-defined.

User-defined presets will be stored in the preset library - in this way installers will not have to define all the values each time they are configuring a new installation.

By selecting *Edit Presets*, or on the Settings screen (with expert mode on or not), custom parameters can be set as follows:

Absorption voltage

Set the absorption voltage.

Adaptive absorption time

Select with adaptive absorption time or fixed absorption time will be used. Both are better explained below:

Fixed absorption time: The same length of absorption is applied every day (when there is enough solar power) by using the maximum absorption time setting. Be aware that this option can result in overcharging your batteries, especially for lead batteries and system with shallow daily discharges. See your battery manufacturer for recommended settings. *Note:* make sure to disable the tail current setting to make the same absorption time every day. The tail current could end absorption time sooner if the battery current is below the threshold. See more information on the tail current setting section below.

Adaptive absorption time: The charge algorithm can use an adaptive absorption time: it automatically adapts to the state of charge in the morning. The maximum duration of the absorption period for the day is determined by the battery voltage as measured just before the solar charger begins operation each morning (12 V battery values used - Multiply Battery voltage by 4 for 48V):

Battery voltage Vb (@start-up)	Multiplier	Maximum absorption times
Vb < 11.9 V	x 1	06:00 hours
> 11.9 V Vb < 12.2 V	x 2/3	04:00 hours
> 12.2 V Vb < 12.6 V	x 1/3	02:00 hours

Battery voltage Vb (@start-up)	Multiplier	Maximum absorption times
Vb > 12.6 V	x 2/6	01:00 hours

The multiplier is applied to the maximum absorption time setting and this results in the maximum duration of the absorption period used by the charger. The maximum absorption times shown in the last column of the table are based on the default maximum absorption time setting of 6 hours.

Maximum absorption time (hh:mm)

Set the absorption time limit. Only available when using a custom charge profile.

Enter the time value in the notation hh:mm, where hours are between 0 and 12; and minutes are between 0 and 59.

Float voltage

Set the float voltage.

Re-bulk voltage offset

Set the voltage offset that will be used over the float voltage setting that will determine the threshold that the charge cycle will restart.

E.g.: For a Re-bulk voltage offset of 0.1V and a float voltage setting of 13.8 V, the voltage threshold that will be used to restart the charge cycle will be 13.7 V. In other words, if the battery voltage drops below 13.7 V for one minute, the charge cycle will restart.

Equalization voltage

Set the equalization voltage.

Equalization current percentage

Set the percentage of the Max charge current setting that will be used when equalisation is performed.

Automatic Equalization

Set-up the frequency of the auto equalize function. Available options are between 1 and 250 days:

- 1 = daily
- 2 = every other day
- ...
- 250 = every 250 days

Equalization is typically used to balance the cells in a lead battery, and also to prevent stratification of the electrolyte in flooded batteries. Whether (automatic) equalization is necessary, or not, depends on the type of batteries, and their usage. Consult your battery supplier for guidelines.

When the Automatic equalization cycle has initiated, the charger applies an equalization voltage to the battery as long as the current level stays below the equalization current percentage setting of the bulk current.

Duration of the Automatic equalization cycle

In the case of all VRLA batteries and some flooded batteries (algorithm number 0, 1, 2 and 3) automatic equalization ends when the voltage limit (maxV) has been reached, or after a period equal to (absorption time/8) - whichever comes first.

For all tubular plate batteries (algorithm numbers 4, 5 & 6); and also for the user-defined battery type, automatic equalization will end after a period equal to (absorption time/2).

For the Lithium battery type (algorithm number 7), equalization is not available.

When an automatic equalization cycle is not completed in one day, it will not resume the next day. The next equalization session will take place according to the interval set in the 'Auto Equalization' option.

The default battery type is a VRLA battery and any user-defined battery will behave as a tubular plate battery with regard to equalization.

Equalisation stop mode

Set how the equalisation will end. There are two possibilities, first is if the battery voltage reaches the equalisation voltage and the second is on fixed time, where the maximum equalisation duration is used.

Maximum equalisation duration

Set the maximum time that the equalisation phase will last.

Tail current

Set the current threshold that will be used to finish absorption phase before the maximum absorption time expires. When the battery current gets below the tail current for one minute, the absorption phase will end. This setting can be disabled by setting it to zero.

Temperature compensation

Many types of battery require a lower charge voltage in warm operating conditions, and a higher charge voltage in cold operating conditions.

The configured coefficient is in mV per degree Celsius for the whole battery bank, not per cell. The base temperature for the compensation is 25°C (77°F), as shown in the chart below.

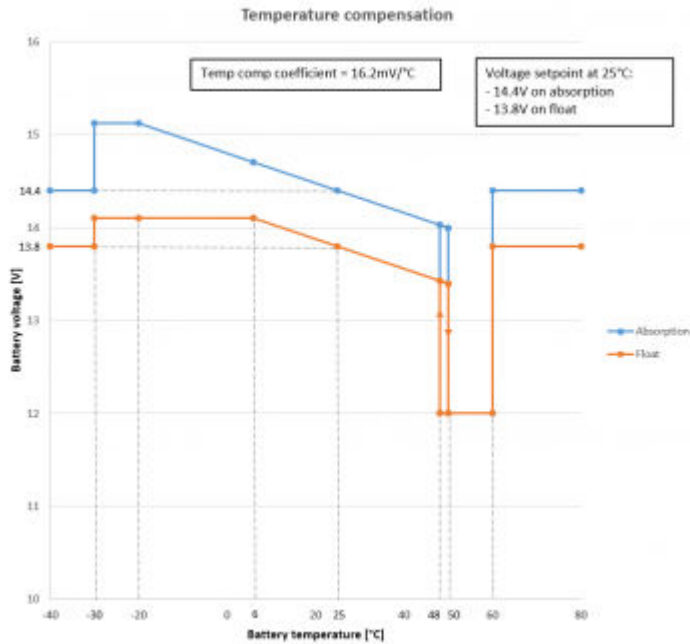

With a temperature sensor installed to the User I/O connection block; the actual battery temperature will be used for compensation; throughout the day.

Low temperature cut-off

This setting can be used to disable charging at low temperatures as required by Lithium batteries.

For Lithium Iron Phosphate batteries this setting is preset at 5 degrees Celsius, for the other battery types it is disabled. When creating a user defined battery the cut-off temperature level can be adjusted manually.

Manual Equalization - Start now

Selecting 'Start now' on 'Manual equalisation' allows manual initiation of an Equalization cycle. To allow the charger to equalize the battery properly use the manual equalize option only during absorption and float periods, and when there is sufficient sunlight. Current and voltage limits are identical to the automatic equalize function. The duration of the equalisation cycle is limited to a maximum of 1 hour when triggered manually. Manual equalization can be stopped at any time by selecting 'Stop Equalize'.

4. Operation

4.1. Device display

The inverter has an LCD screen that displays operational information.

Inverter:

Inverter state, Power output, Frequency and AC Voltage

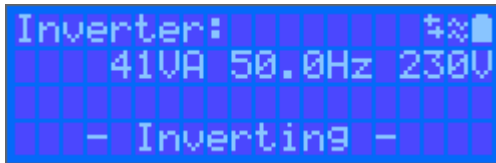

Battery:

Battery Power (charging shows positive number, discharging shows negative number), Current, DC voltage, Temperature (*), State-of-charge (*) and Time-to-go (*). Battery state (e.g. discharging, bulk, absorption, float, etc).

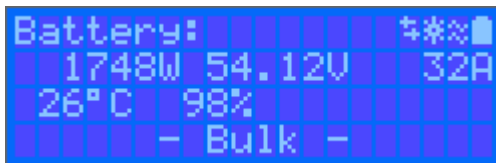





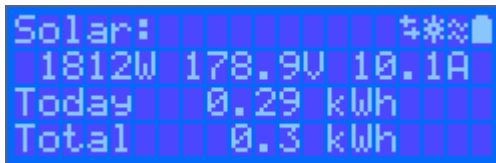

(*) These items are only visible if the data is available.

Solar:

Solar Power, Voltage and Current, kWh daily and total Yield.



In the top right of the display are other system information icons.

	Communicating on any interface (e.g., Bluetooth, VE.Can, etc.)
	Bluetooth Enabled, Icon colour changes when connected
	MPPT Active
	(Blinking) Error or Warning
	Inverter Active
	Battery, fill corresponds with voltage, blinks when empty

4.2. STATUS - Live Data Information



- **MPPT [Model Number]** confirms the connected device. A custom name can also be set if desired.
- **Solar 'Gauge' icon** shows the dynamic real-time power output from the solar array. With regard to the Solar Panel voltage, note that the Solar charger will only operate once the Panel voltage has risen more than 5V above battery voltage.
- **Battery - Voltage** The voltage measurement is taken at the battery terminals of the Solar charger.
- **Battery - Current** This reading shows the current flowing-to, or drawn-from the battery terminals of the Solar charger. Note that in the case of the 100/20 Solar chargers and smaller - which have a dedicated load output - a Positive notation alongside the current reading means that current is flowing to the battery; whereas a Negative notation means that current is being drawn from the battery.
- **Battery - State:**
 - Bulk: During this stage the Controller delivers as much charge current as possible to rapidly charge the batteries. When the battery voltage reaches the Absorption voltage setting, the Controller activates the Absorption stage.
 - Absorption: During this stage the Controller switches to the constant voltage mode, where a pre-set absorption voltage, suitable to the battery type (See section 4.1 Battery Settings below), is applied. When the charge current decreases below the Tail current and/or the pre-set Absorption time has elapsed, the battery is fully charged. The Controller switches to the Float stage. The Tail current is 1A for models 100/20 and smaller; and 2A for larger models. (When an automatic equalisation is being performed this will also be reported as 'Absorption'.)
 - Float: During this stage the float voltage is applied to the battery to maintain a fully-charged state. When the battery voltage drops below float voltage during at least 1 minute, a new charge cycle will be triggered.
 - Equalization: This is shown when 'Start equalization now' is pressed in the battery settings. The charger applies the equalization voltage to the battery as long as the current level stays below 8% (Gel or AGM) or 25% (tubular plate) of the bulk current.
- * **Menu items only available on MPPT models with load output (100/20 and smaller.)**
 - **Load output on/off** The function of the load output switch is to disconnect the load when the battery is low on power in order to avoid damaging it. See the configuration section (4.2 below) for available load switching algorithms.
 - **Load current** This shows the current being drawn by electronic devices, lights, fridge, etc.

Note that for the load output reading to be reliable, all loads must be wired directly to the load output ...including their negative terminals. See manual or consult your installer for details.

Note that some loads (especially inverters) are best connected directly to the battery. In such cases the load output does not show a reliable reading - the current drawn by the inverter, for example, will not be included. Consider adding a [BMV battery monitor](#) which will measure all current going to - or being drawn from the battery, including loads connected directly to the battery ...not just the load output terminals of the charge controller.

Is my battery being charged?

The battery will be charged whenever the power available from the PV panels exceeds the power being drawn by the loads (lights, fridge, inverter, etc.).

You can only tell if that is the case with Charge Controllers which have all loads connected to the load output terminals. Remember: any loads connected directly to the battery can't be monitored by the Solar Charger.

4.3. HISTORY - Thirty-day Graphic

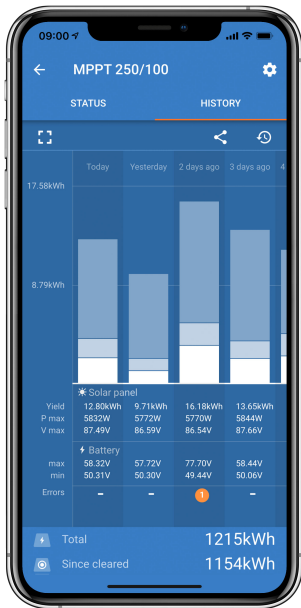

(The fragmented square icon (top left) allows you to toggle between 'portrait' and 'landscape' screen presentations.)

A summary of activity for the last 30 days is presented graphically. Swipe the bar left or right to show any of the previous 30 days.

The daily log shows:

- **Yield:** The energy converted for that day.
- **P max:** The maximum power recorded during the day.
- **V max:** The highest voltage from the PV array during the day.

Clicking on any day/bar in the graph will expand the information to show charge-status times - both as hrs/m; and also as a percentage of the 'charge' day. This graphic provides an at-a-glance representation of how much time your charger is spending in each of three modes: Bulk / Absorption / Float.

Tip! You can use the charge times to see if the PV array is properly sized for your requirements. A system which never reaches 'Float' may need more panels; or perhaps the load could be reduced?

It is possible to export the history as a comma separated file (.csv) by clicking the three connected dots at the top right of the history screen:

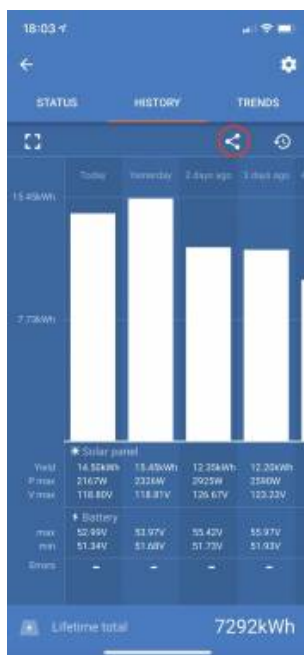

This is an example of the exported data for 3 of 30 days:

Days ago	Yield (Wh)	Max. PV power (W)	Max. PV voltage (V)	Min. battery voltage (V)	Max. battery voltage (V)	Time in bulk(m)	Time in absorp. (m)	Time in float (m)	Last error	2nd last error	3rd last error	4th last error
0	14500	2167	118.80	51.34	52.99	748	0	0	0	0	0	0
1	15450	2326	118.81	51.68	53.97	869	0	0	0	0	0	0
2	12350	2925	126.67	51.73	55.42	872	0	0	0	0	0	0

Battery Voltage

The first figure shows the maximum battery voltage for the day ...the figure below is the minimum battery voltage.

Errors

Shows the number of errors (if any) for the day, to see the error codes click on the orange point. See [MPPT Solar Charger Error Codes](#). (You may need to slide the display on your device up to see the errors.)

Total

This shows the total energy converted by the installation and is not re-settable.

Since Cleared

This shows how much energy has been converted by the installation since the last reset.

4.4. Protections and automatic restarts

4.4.1. Overload

Some loads like motors or pumps draw large inrush currents during start-up. In such circumstances, it is possible that the start-up current exceeds the over current limit of the inverter. In this case the output voltage will quickly decrease to limit the output current of the inverter. If the over current limit is continuously exceeded, the inverter will shut down for 30 seconds and then automatically restart. After three restarts followed by overload within 30 seconds of restarting, the inverter will shut down and remain off. To restart normal operation, disconnect the load, Switch Off the inverter, then switch it On.

4.4.2. Low battery voltage thresholds (adjustable in VictronConnect)

The inverter will shut down when the DC input voltage drops below the low battery shutdown level. After a minimum shutdown time of 30 seconds, the inverter will restart if the voltage has risen above the low battery restart level.

After three shut down and restarts, followed by a low battery shutdown within 30 seconds of restarting, the inverter will shut down and stop retrying based on the low battery restart level. To override this and restart the inverter, switch it Off, and then On, and limit loads to enable recharging of the battery with solar energy.

The solar MPPT will continue to recharge the battery even when the inverter has shut down due to low battery voltage. If the inverter has shut down 4 times, it will again attempt to switch itself back on as soon as the DC voltage stays above the Charge Detect level for 30 seconds.

See the Technical Data table for default low battery shut down, restart and charge detect levels. They can be adjusted with VictronConnect (computer or app).

Additionally another external MPPT or battery charger can also be used to recharge the battery to reach the Restart Voltage or Charge Detect voltage level. !!! If using the allow to charge signal functionality, it must remain above the minimum voltage, so if the battery is completely dead it will not allow charging to start. In this case, you can temporarily disable this function in VictronConnect to allow charging to resume, then enable it again.

See the Technical Data table for default low battery shut down and restart levels. They can be changed with VictronConnect (computer or app). Alternatively Dynamic Cut-off can be implemented, see <https://www.victronenergy.com/live/ve.direct:phoenix-inverters-dynamic-cutoff>

4.4.3. High battery voltage

Reduce DC input voltage and/or check for a faulty battery- or solar-charger in the system. After shutting down due to a high battery voltage, the unit will first wait 30 seconds and then retry operation as soon as the battery voltage has dropped to acceptable level.

4.4.4. High temperature

A high ambient temperature or enduring high load may result in shut down to over temperature. The inverter will restart after 30 seconds. The inverter will continue to try and resume operation, and will not stay off after multiple retries. Reduce load and/or move inverter to better ventilated area.

5. Troubleshooting

Check the Victron website for error codes and troubleshooting: <https://www.victronenergy.com/live/mppt-error-codes>

6. Technical Specifications

INVERTER RS SMART	48/6000
	INVERTER
DC Input voltage range	38 – 64V
Output	Output voltage: 230 VAC ± 2% Frequency: 50 Hz ± 0,1% (1)
Continuous output power at 25°C	Increases linearly from 4800W at 46 VDC to 5300W at 52 VDC
Continuous output power at 40°C	4500W
Continuous output power at 65°C	3000W
Peak power	9kW for 3 seconds
Short-circuit output current	50A
Maximum efficiency	96.5% at 1 kW load 94% at 5 kW load
Zero load power	20W
Low battery shutdown	37.2 V (adjustable)
Low battery restart	43.6 V (adjustable)
	SOLAR
Maximum DC voltage	450 V
Start-up voltage	120 V
MPPT voltage range (2)	80 – 450 V
Maximum operational PV input current	18 A
Max. PV short circuit current reverse polarity protection (3)	20A
Earth leakage trip level	30 mA
Isolation fail level (detection before start-up)	100 kΩ
	CHARGER
Programmable charger voltage range (2)	Minimum: 36 V Maximum 62 V
Charge voltage 'absorption'	default: 57.6 V
Charge voltage 'float'	default: 55.2 V
Maximum charge current (4)	100 A
Maximum DC charging power	4000 W
Battery temperature sensor	Included
Battery voltage sense	Yes
	GENERAL
Parallel and 3-phase operation	No
Auxiliary output	No
Programmable relay (5)	Yes
Protection (6)	a - g
Data Communications	VE.Direct port, VE.Can port & Bluetooth (7)
General purpose analog/digital in port	Yes, 2x

INVERTER RS SMART	48/6000
Remote on-off	Yes
Operating temperature range	-40 to +65°C (fan assisted cooling)
Humidity (non-condensing)	max 95%
	ENCLOSURE
Material & Colour	steel, blue RAL 5012
Protection category	IP21
Battery-connection	Two M8 bolts
PV Connection	2 positive & 2 negative MC4
230 V AC-connection	Screw terminals 13 mm ² (6 AWG)
Weight	11 kg
Dimensions (hwxwd)	425 x 440 x 125 mm
	STANDARDS
Safety	EN-IEC 60335-1, EN-IEC 60335-2-29, EN-IEC 62109-1, EN-IEC 62109-2
Emission, Immunity	EN 55014-1, EN 55014-2 EN-IEC 61000-3-2, EN-IEC 61000-3-3 IEC 61000-6-1, IEC 61000-6-2, IEC 61000-6-3
<p>1) Can be adjusted to 60 Hz</p> <p>2) MPPT operating range is also constrained by battery voltage - PV VOC should not exceed 8x battery float voltage. For example, a 52,8V float voltage results in a maximum PV VOC of 422,4V. See product manual for further information.</p> <p>3) A higher short circuit current may damage the controller if PV array is connected in reverse polarity.</p> <p>4) The maximum charge current from the built in MPPT is 80A, to reach the 100A maximum charge current of the unit requires additional AC PV connected.</p> <p>5) Programmable relay which can be set for general alarm, DC under voltage or genset start/stop function, including minimum closed time and relay-off delay. DC rating: 4A up to 35VDC and 1A up to 70VDC</p> <p>6) Protection key:</p> <ul style="list-style-type: none"> a) output short circuit b) overload c) battery voltage too high d) battery voltage too low e) temperature too high f) 230 VAC on inverter output g) Solar earth leakage <p>7) The Inverter RS is not currently compatible with VE.Smart Networks</p>	

7. Appendix

7.1. Appendix A : Connection Overview

Figure 2. Inverter RS Front

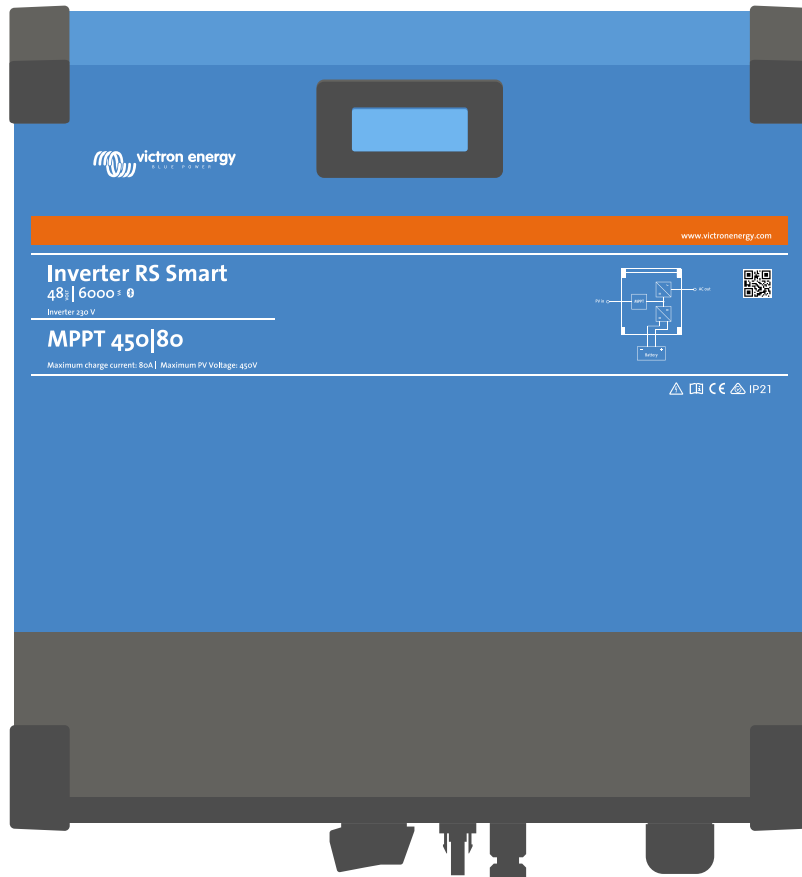

Figure 3. Inverter RS Bottom

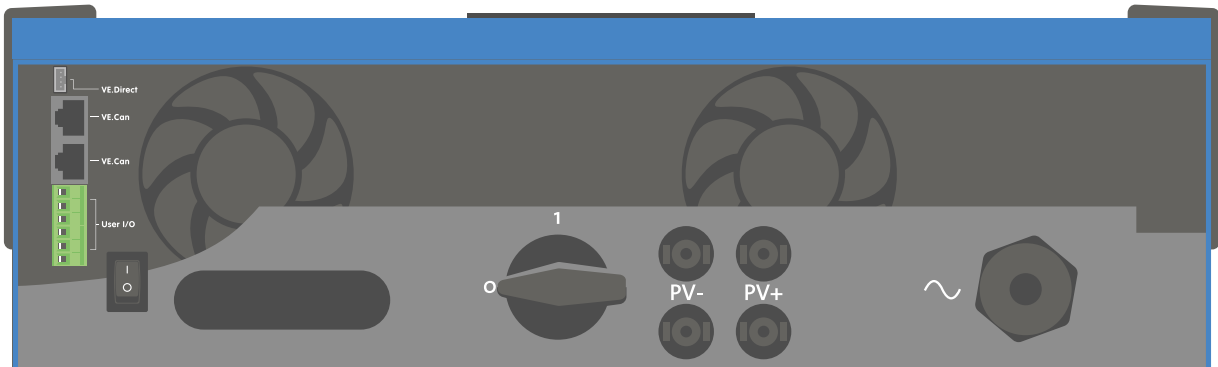
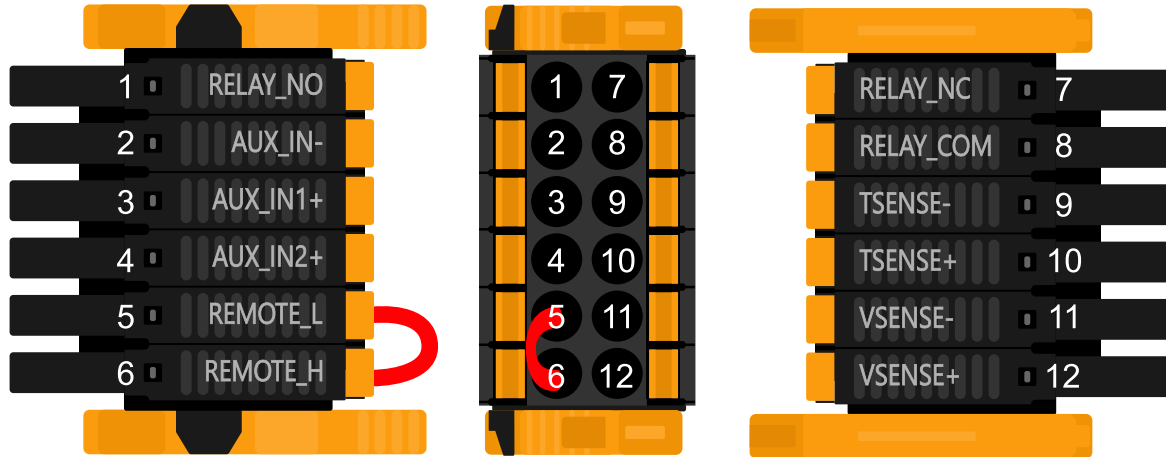

Figure 4. User I/O



User I/O Connector is located on bottom left side of connection area, diagram shows 3 perspectives. Left Side - Top - Right Side

Table 4. User I/O Functions - See Installation Section for more details.

Number	Connection	Description
1	Relay_NO	Programmable relay Normally Open connection
2	AUX_IN -	Common negative for programmable auxiliary inputs
3	AUX_IN1+	Programmable auxiliary input 1 positive connection
4	AUX_IN2+	Programmable auxiliary input 2 positive connection
5	REMOTE_L	Remote on/off connector Low
6	REMOTE_H	Remote on/off connector High
7	RELAY_NC	Programmable relay Normally Closed connection
8	RELAY_COM	Programmable relay common negative
9	TSENSE -	Temperature Sensor negative
10	TSENSE +	Temperature Sensor positive
11	VSENSE -	Voltage Sensor negative
12	VENSE +	Voltage Sensor positive

7.2. Appendix B : Block Diagram

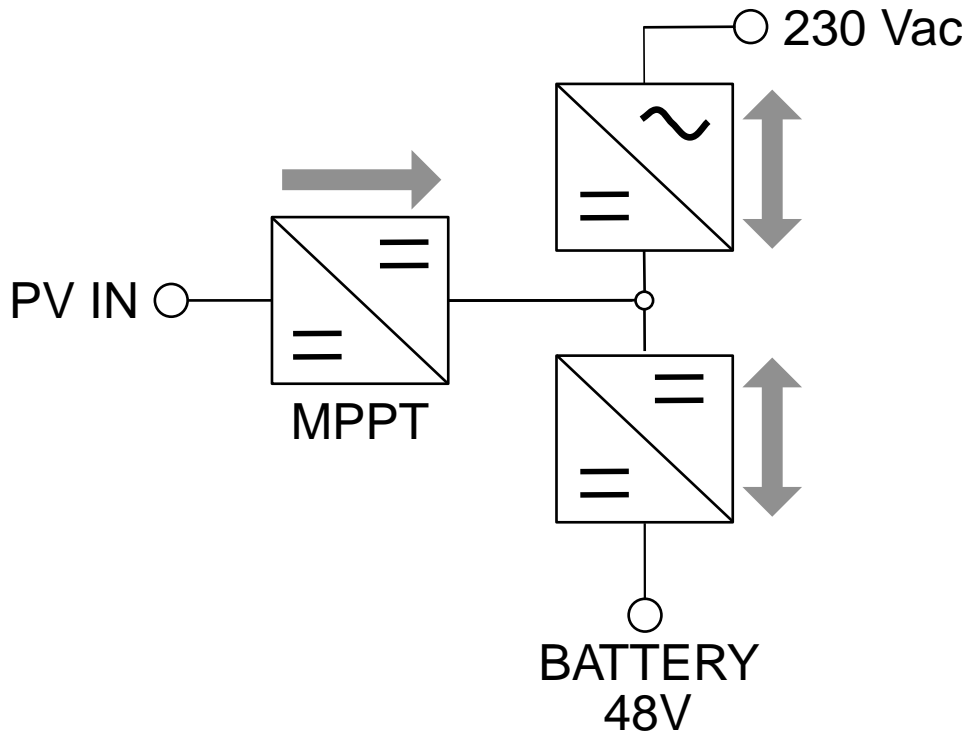

7.3. Appendix C : Example Wiring Diagram

Figure 5.

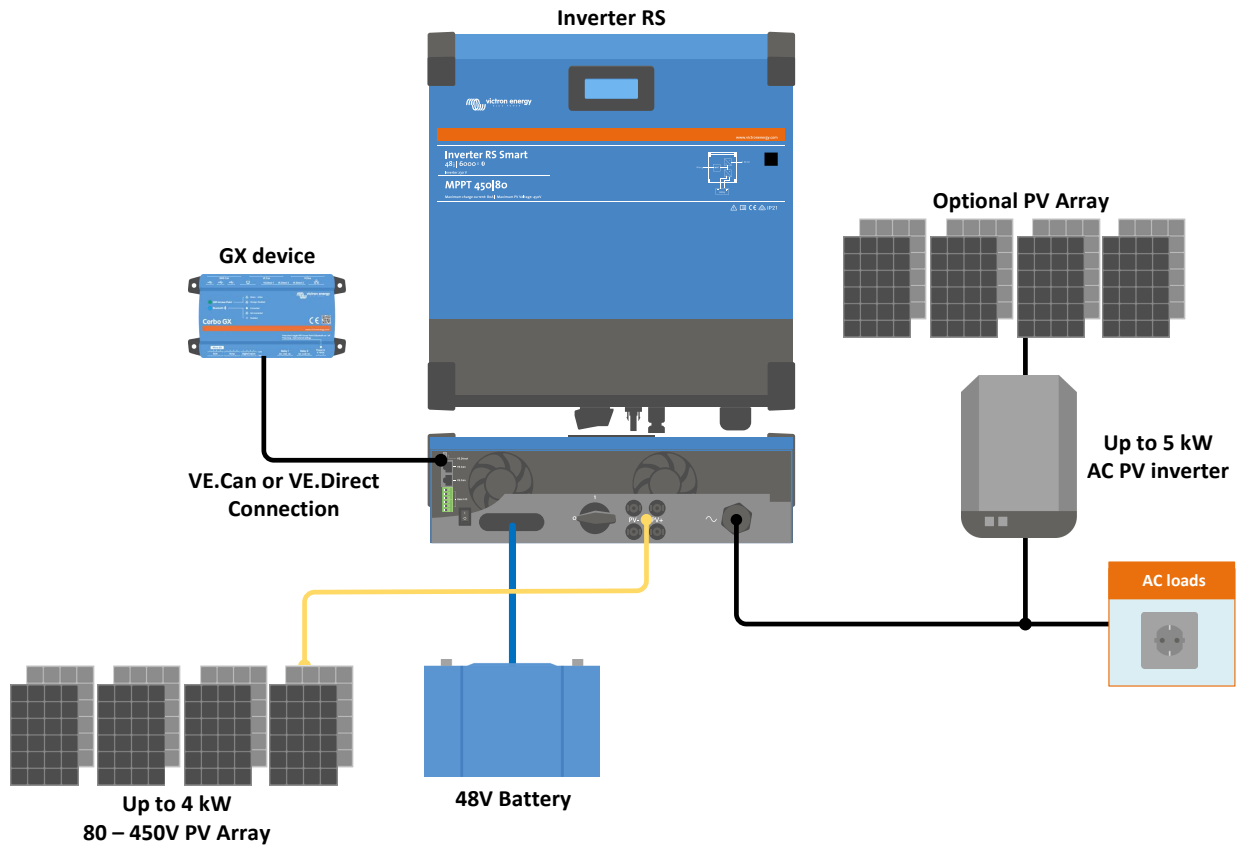

7.4. Appendix D : Dimensions

