

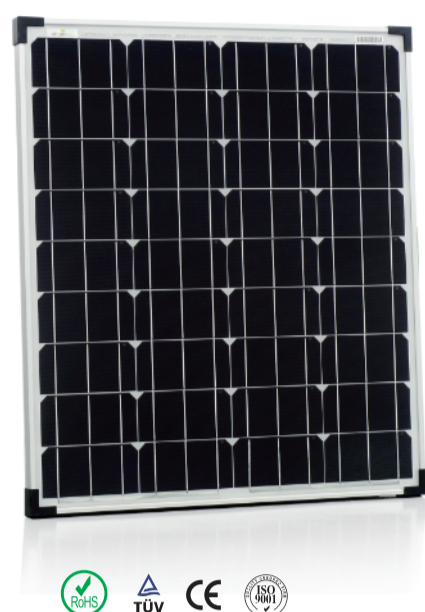

Offgridtec High Quality Solar Panel

Mono 80W 3-01-001275



Key Features

-  Excellent low-light
-  High Quality Bill of Materials
-  Reinforced Module Warranty
-  High Efficiency A grade cell
-  Universal Design (residential, commercial, RV, camping and all other off grid application)

PRODUCT & ADVANTAGE

Offgridtec provides industry leading product coverage for all our modules to ensure our customers achieve superior long-term value from their solar installation. In addition to a 5-year warranty, which covers unanticipated module damage, Offgridtec implements a 25-year performance guarantee known as Reinforced Module Warranty.

Offgridtec's solar modules are with low iron tempered glass, A grade cell insure more power output and long term reliability. Our meticulous design and stringent quality control ensure our modules deliver a higher PV energy yield in PV system as well. Our in-house PV testing facilities guarantee all modules or materials meet the highest quality standard.

Product Warranty for 5 years Performance guarantee for 25 years

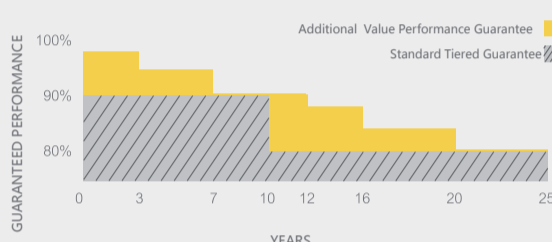

*The specifications made herein may deviate slightly and are not guaranteed. Due to ongoing innovation, research and product enhancement we reserve the right to make any adjustments to the information contained herein at any time without notice. Please always obtain the most recent revision of datasheet which shall be duly incorporated into the binding contract made by the parties governing all transactions related to the purchase and sale of the products described herein.

<http://www.offgridtec.com/>
info@offgridtec.com

Landshuterstraße 141 - 143
84307 Eggenfelden
Germany
Telephone: +49(0)8721/9829740

Mono 80W 3-01-001275

High Efficiency Monocrystalline solar panel

Electrical Characteristics

Product code	3-01-001275
Maximum power (Pmax)	80Wp
Voltage at Pmax (Vmp)	17.8V
Current at Pmax (Imp)	4.50A
Open-circuit voltage (Voc)	22.3V
Short-circuit current (Isc)	4.86A
Temperature coefficient of Voc	-0.45%/°C
Temperature coefficient of Isc	-0.45%/°C
Temperature coefficient of power	-0.45%/°C
NOCT	45+/-2°C
Operating temperature	-40°C to +85°C
Maximum system voltage	1000 VDC
Power tolerance	-3% to +3%

*Measured at STC Conditions: Irradiance: 1,000W/m² - AM1.5 Spectrum - Temperature: 25°C
Electrical parameters may vary by -5% to +5%

Module Diagram

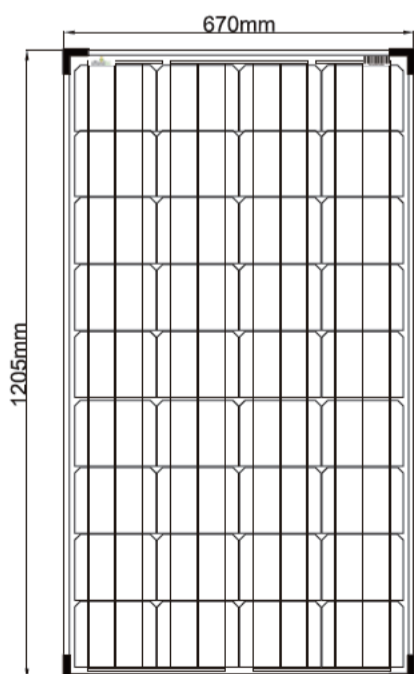

Dimensions in brackets are in millimeters.
Unit: mm

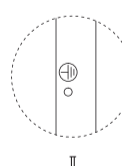
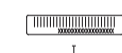
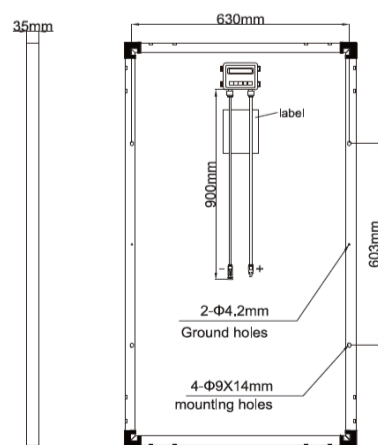

Characteristics

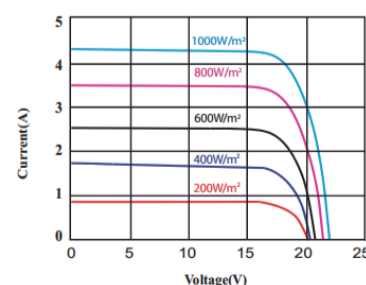

Specifications

Cells type/Array	156x156(4x9)
Junction box	Water proof IP67, 1000VDC
Module dimension (mm)	670X770X30
Net Weight/Gross Weight (kg)	6/7
Number of Bypass Diodes & Type	2pcs, Bypass Diodes
Packing information	1pcs/ctn

<http://www.offgridtec.com/>
info@offgridtec.com

Landshuterstraße 141 - 143
84307 Eggenfelden
Germany
Telephone: +49(0)8721/9829740